















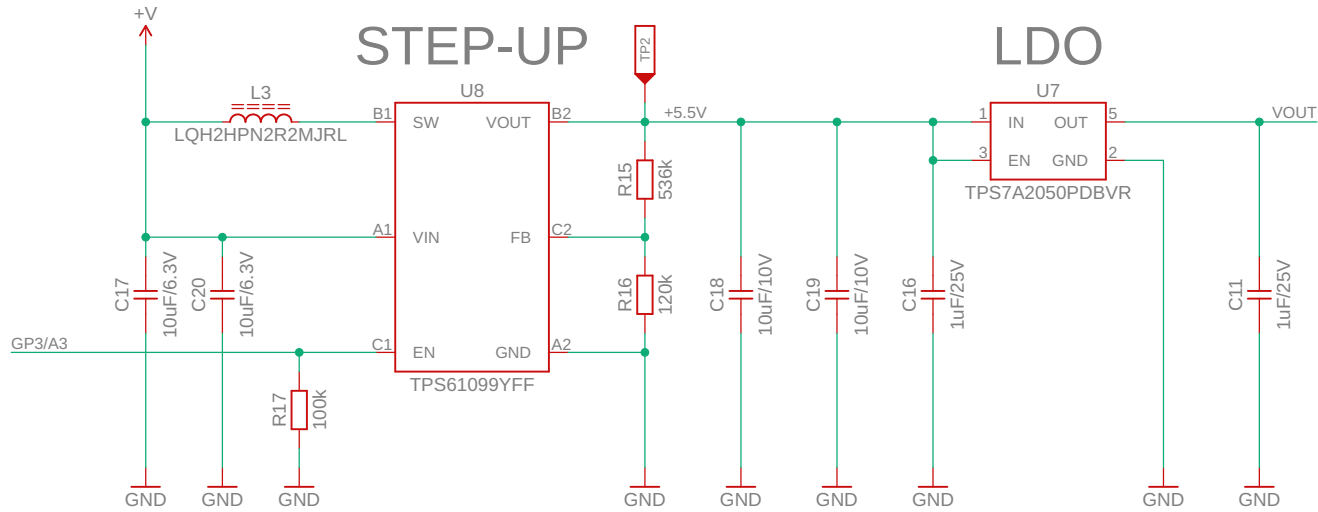

- JP1  GND
- JP2  VDD
- JP3  SCL
- JP4  SDA
- JP5  GP0/A0
- JP6  GP1/A1
- JP7  GP2/A2
- JP8  GP3/A3
- JP9  +V



- +V  JP10
- GND  JP11
- VDD  JP12
- VIN  JP13
- GND  JP14
- INP  JP15
- INM  JP16
- VOUT  JP17



HARDWARIO AGILE HARDWARE DEVELOPMENT WWW.HARDWARIO.COM	CHESTER-X7	
	REVISION: 2.1 MODIFIED: 25.04.2024 13:02	1/2

DIFF

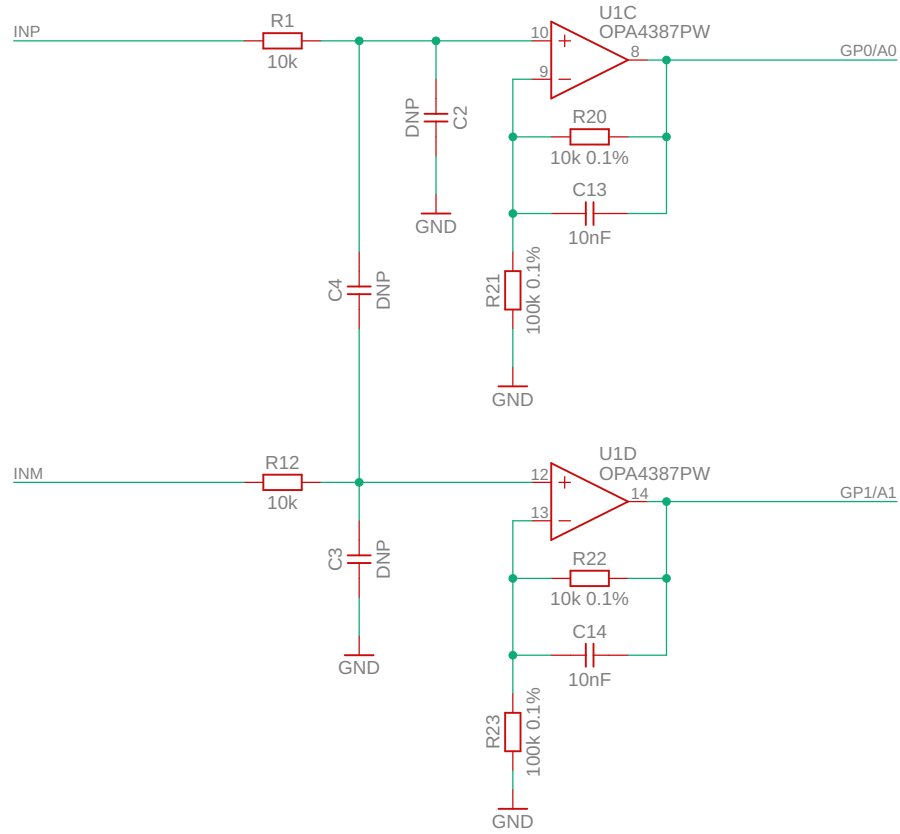

DUMMY

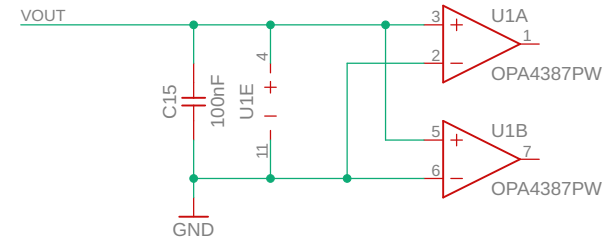

VOLTAGE

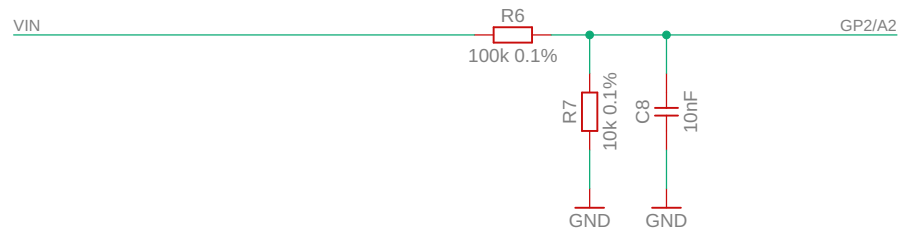

HARDWARIO AGILE HARDWARE DEVELOPMENT WWW.HARDWARIO.COM	CHESTER-X7	
	REVISION: 2.1	
	MODIFIED: 25.04.2024 13:02	2 / 2